



Part of the **thirstywork** family

Cobra 2-way Tap

Chilled • Ambient • Sparkling • Filtered



Call **01392 877 172** Email hello@thirstywork.com www.puraserve.co.uk

PuraServe is part of the thirsty work family of companies

*New models only



hydrateconsciously!
We're committed to reducing plastic waste

Cobra 2-way Tap

High volume still and sparkling water



KEY FEATURES

- Brass font with chrome finish as standard
- Ambient, chilled and sparkling water options
- 3 - 10°C temperature
- Timeless design
- Over font installation
- Optional clamp-to-the-bar fixing
- Comes with 2 round Pura badge holders
- Optional drip tray
- With **PuraFiltration**

COLOUR OPTIONS



Chrome plated



Plastic Drip Tray

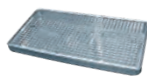

Stainless Steel Drip Tray

WATER OPTIONS



Chilled



Filtered



Sparkling



Ambient

INSTALLATION OPTIONS



Over Font



Under-counter Unit

A professional, robust solution with 2 outlets, enabling you to dispense chilled, ambient or sparkling water.

The under-counter unit can be installed under the bar counter or in remote corners of a room to dispense large quantities of water, improving efficiency in any type of venue; ideal for high volume water bottle management.

The optional clamp-to-the-bar fixing makes installation simple.

DIMENSIONS

Tap height:	590mm
Tap width:	179mm
Tap depth:	250mm
Dispense height:	300mm
Dispense height incorporating drip tray:	270mm



The Cobra 2-way Tap dispenses sparkling and chilled filtered water, instantly from high output under-counter units.

The timeless design looks professional on all bars and counters, and the tall dispense height allows easy bottle and jug filling.

The Cobra 2-way Tap is supplied with four printed Pura badges as standard, making it easy to choose your preferred water dispense option. The under sink unit fits discretely under any worktop or counter-top.



Why choose **PuraServe?**

Everything you'll need is included within your rental price:

- ✓ Site survey
- ✓ Water dispensing system
- ✓ 60 re-usable Pura glass bottles
- ✓ 120 reusable silver bottle caps
- ✓ 1 glass washer tray
- ✓ 6 monthly PuraFilter changes
- ✓ 6 monthly system health check
- ✓ 6 monthly full sanitisation
- ✓ Full call-out warranty, parts and labour
- ✓ Delivery and installation
- ✓ Option: personalised glass bottles



Enjoy these additional benefits:

- ✓ Cost from just 3p per 750ml bottle serving
- ✓ Reduce carbon footprint
- ✓ Reduce recycling costs
- ✓ Cut single-use, plastic bottled water
- ✓ Gain fridge and storeroom space
- ✓ Reduce environmental impact of transportation and packaging waste
- ✓ Bespoke bottle printing from £9.50+VAT each

Visit our website for more information and pricing www.puraserve.co.uk

TAP DIMENSIONS

Dimensions shown in mm

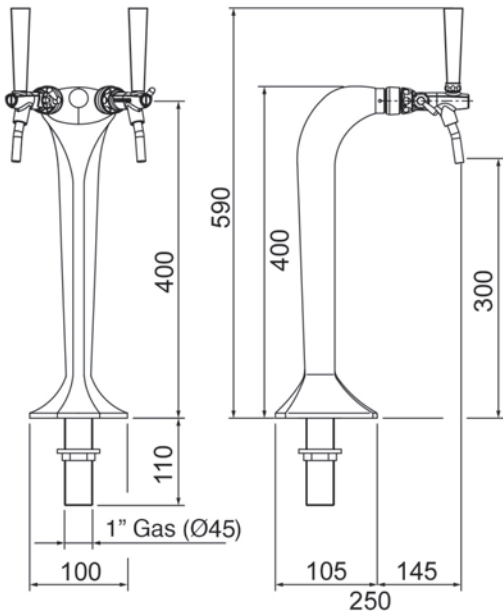

INSTALLATION REQUIREMENTS

The Cobra Tap requires adequate worktop and cupboard space for installation. Please ensure that the following is available where the system is to be installed:

- ✓ **Minimum installation worktop depth 350mm.**
(Allows for drip tray at size: W 410mm x D 225mm x H 30mm).
- ✓ **Minimum height clearance requirement: H 600mm.**
- ✓ **Minimum base unit installation cupboard space:**
30 model: W 455mm x D 600mm x H 450mm.
45 model: W 455mm x D 600mm x H 450mm.
65 model: W 550mm x D 620mm x H 550mm.
- ✓ **A potable mains water supply within 5 metres of unit installation location.**
- ✓ **A 240-volt electric socket within 1 metre of unit location.**
- ✓ **A cylinder of food grade CO₂ gas.**
(Applies to customers choosing a sparkling water option only.)
- ✓ **Worktops are clear and in a finished state.**
- ✓ **Sufficient ventilation is in place for the refrigerated unit**
(if housed by a cupboard).
- ✓ **Any cupboard construction to house the equipment is complete** (if applicable).

All of the above can be confirmed in your site survey.

OUTPUT OPTIONS

The Cobra Tap is fed from an under-sink unit. There are many output options to suit your requirements.

Under-counter model	Chilled litres/hr	Sparkling litres/hr	Rating (kW) @ 230V	Under-counter unit dimensions (mm)
JClassIN 30 10 - 40 people	30	N/A	350W	W 255 x D 400 x H 400
JClassIN 45 30 - 50 people	45	N/A	350W	W 255 x D 400 x H 400
NiagaraIN 65 50 - 100 people	65	65	300W	W 350 x D 420 x H 500
NiagaraIN 120 100 - 180 people	120	120	500W	W 350 x D 480 x H 500
NiagaraIN 180 180 - 300 people	180	180		W 350 x D 530 x H 500

UNDERCOUNTER UNIT DIMENSIONS

JClassIN

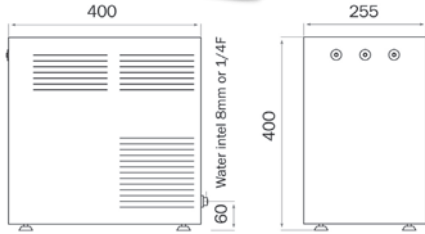

NiagaraIN 65

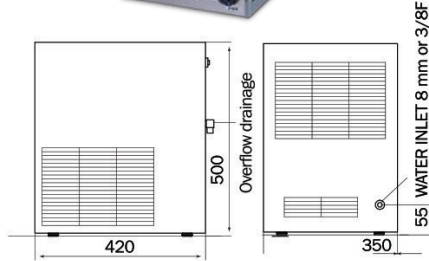

NiagaraIN 120

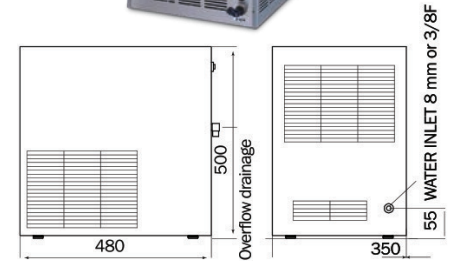

AVAILABLE ACCESSORIES



Pura Reusable Glass Bottles

Order additional PuraServe glass water bottles for use with your water dispenser.



Bespoke Printed Glass Bottles

Add your own company logo to our range of reusable glass water bottles. Choice of screw cap colours.

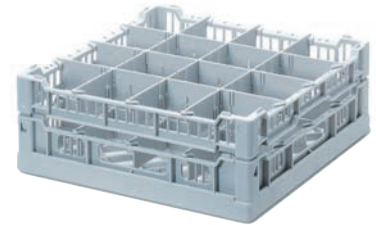

Glass Bottle Washer Trays

Wash Pura bottles faster with additional 400mm or 500mm commercial glasswasher trays.

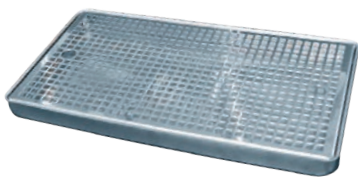

Drip Trays

Choose from plastic or stainless steel drip trays to complement your Cobra Tap.



Part of the **thirstywork** family

Call **01392 877 172** Email hello@thirstywork.com www.puraserve.co.uk

PuraServe is part of the thirsty work family of companies